



Corporate Social Responsibility Report 2011

Corporate Social Responsibility



Contents

Interview

How should public transportation systems deal with disasters? 2

Management

Corporate Governance 6
Internal Governance/Compliance 7

Safety Information Report

Measures to Improve Safety 8

Social Report

Together with our Stakeholders 12

Environmental Reports

Environmental Policy and Management Systems 15
Mid-Term Environmental Goals 16
FY2010 Performance and Strategic Policies for FY2011 18
Reducing CO₂ Emissions to Prevent Global Warming 20
Protecting Biodiversity 22
Effective Use of Resources and Consideration for the Local Environment 23
Environmental Accounting 24
Environmental Burden Data 25

Corporate Outline

Company Name	Nankai Electric Railway Co., Ltd.
Established	December 1885
Head Office	5-1-60 Namba, Chuo-ku, Osaka 542-8503
Website	http://www.nankai.co.jp/
Paid-in Capital	¥63.7 billion
Operating Profit	¥79.4 billion
No. of Shareholders	57,407
No. of Employees	3,122 (Including 347 staff on loan)
Managed track	154.8km
Rolling Stock	694

(As of March 31, 2011)

Status of the Corporate Group

(No. of Consolidated Employees 8,307)

	(No. of Companies)	
Transportation	29	Railways, rail track management, buses, ocean freight, cargo transportation, train maintenance businesses
Real Estate	4	Real estate leasing, real estate sales
Distribution Business	6	Shopping Center management, sales of commodities
Leisure and Services	24	Amusement Park management, travel agency, hotels and <i>ryokan</i> Japanese inns, leasing of <i>kyotei</i> motorboat race facilities, building management and maintenance businesses, printing, advertising agency
Construction	5	Construction
Other	6	Accounting and Data Processing Agency Services

* The Nankai Electric Railway Co. Ltd. is counted on more than one occasion in the company totals shown above.

* Subsidiary companies and affiliates are also included in the totals shown above.

Financial Status

(Consolidated Results for fiscal 2010)

■ Composition ratio of operating profit by segment

(¥ millions)

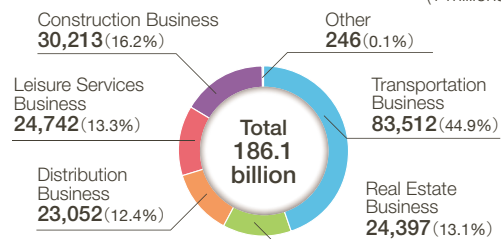

■ Transition of Operating Profit

(¥ millions)

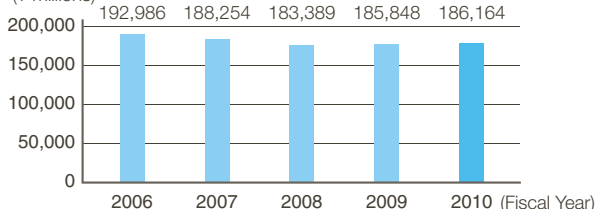

■ Transition of Ordinary Profit and Net Profit for the Fiscal Year

(¥ millions)

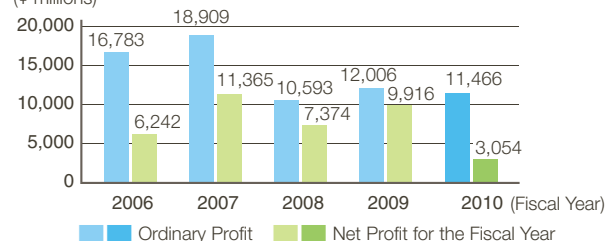

■ Editorial Policy

This report covers more than just our efforts at environmental preservation. The first half will introduce our social relations with content centered on our Safety Information Report and the second half touches on environmental preservation and what we plan to do about this in the future. This report is intended to act as a communication tool between the Company and its stakeholders.

■ Applicable Term

The applicable term of this report refers to fiscal 2010 (running from April 1st 2010 to March 31st 2011), but some sections of this report also cover matters outside of this stated time span.

■ Scope of the Report

The report covers issues related to the Nankai Electric Railway Co. Ltd., but some matters mentioned herein also pertain to the corporate group.

■ Referenced Guidelines

This report references the 'Environmental Accounting Guidelines Ed. 2005' as published by the Ministry of the Environment and conforms with the 'Environmental Accounting Guidelines for Private Railway Businesses Ed. 2008' as published by the ASSOCIATION OF JAPANESE PRIVATE RAILWAYS.

Corporate Philosophy

With expertise and dynamism, forging the way to the future

Contributing to the Community : Justifying public trust as an all-round lifestyle provider, and building a better society

Putting the Customer First : Providing excellent services for the customer, bringing living comfort and cultural enrichment

Future Challenges : Meeting the needs of coming generations with bold energy and creativity

A Dynamic Workplace : Creating a workplace brimming with vitality, harnessing the expertise and personal strengths of every employee



How should public transportation systems deal with disasters?

The earthquake, which occurred on March 11, 2011, off the Pacific Coast of the Tohoku region, caused unimaginable damage. The “Great East Japan Earthquake” will long remain in our memories. We would again like to express our sorrow from the bottom of our hearts for the victims of the disaster. How should railway companies, a form of public transport, respond when earthquakes, tsunami and other calamities occur? We spoke with Toshitami Kaihara, President of the Hyogo Earthquake Memorial 21st Century Research Institute, a public foundation that offers various proposals and conducts research into “safe and secure urban planning” and “turning symbiotic societies into a reality.”

Considering the importance of disaster reduction along with disaster prevention

President Kaihara, you confronted the Great Hanshin-Awaji Earthquake of January 17, 1995, while serving as governor of Hyogo Prefecture. Can you please tell us about what kind of thoughts you had when viewing the situation in the devastated areas in the Great East Japan Earthquake?

Kaihara — I would first like to point out that this is a compounded disaster, involving the earthquake, tsunami and Fukushima nuclear-plant accident. There has never been this kind of damage in the past. What caught your eye in the Hanshin-Awaji quake 16 years earlier was a highway that had toppled over. But even for us, with this kind of experience behind us, the situation of the devastated areas we saw on TV and elsewhere left us speechless.

Watari — In the Great East Japan Earthquake, we got a sense that we were being shown, in many different ways, the awesomeness of a natural disaster that human power was unable to resist. We did listen to all the various discussions on past case studies on tsunami damage with the expectation of appreciating it all. Yet when we saw it in real time, our thoughts were more like: “Is a tsunami really such a horrendous thing?”

If we were to be hit with that kind of tsunami, how could our railway respond, given that Nankai Electric Railway’s main line runs along Osaka Bay? How would we guide our passengers to safe places for evacuation? We gained a strong and renewed recognition of the responsibilities we need to fulfill as a railway company.

It’s often said the initial moves are important when disasters strike, not just for earthquakes

Kaihara — As for the initial response, the most important thing when a disaster occurs is probably to verify the situation accurately, like what kind of dangers are being posed. For instance, with the Uemachi Fault in Osaka, the median tectonic line extends in a pattern that crosses the

Nankai rail lines. It’s said the Tonankai and Nankai earthquakes are certain to occur in the near future, and predictions of tsunami damage are being worked on. It’s important to keep this fully in mind and constantly have preparations in place.

A photograph of Shinji Watari, President and COO of Nankai Electric Railway Co., Ltd. He is a middle-aged man with dark hair, smiling warmly at the camera. He is wearing a dark navy blue suit jacket over a light-colored, possibly white, collared shirt. His hands are clasped in front of him. The background is a modern building with large glass windows and a grey overhang, suggesting an office or public space.

Shinji Watari

President and COO,
Nankai Electric Railway Co., Ltd.

Next, what kind of preparations should be done? Efforts considered to be disaster countermeasures include the construction of buildings to withstand earthquakes, the establishment of dikes to block inundation from river water, and raising the height of tide embankments so that tsunamis are pushed back. Japan has devoted itself to all sorts of disaster prevention efforts, which are said to be at the highest level in the world.

On the other hand, there is also the disaster reduction way of thinking. This is not about confronting the threats posed by nature, but to envisage a certain amount of damage at the time a disaster occurs, and consider preventative measures to make this damage as small as possible. This is a concept that was born in the aftermath of the Hanshin-Awaji Earthquake.

In the case of a railway, the company operates on the assumption that it's impossible to stop a disaster from occurring. So it seems important to put in place preparations in order to ensure the safety of passengers and residents living alongside rail lines (disaster reduction, in other words).

Watari — As our benchmark for disasters that have occurred so far, we've learned from the idea that "this kind of thing is also possible." Based on that, there is a course of events that has empirically raised safety levels with the idea of "so let's take these kinds of measures." How this is brought into play when new disasters occur is important. With humility, we accept whatever kind of situation arises from a disaster, and seriously consider the responses. I think that ties into to what the President says about preparations.

It's important to learn from the past and pass on experience to the next generation

How should Nankai Electric Railway approach its disaster countermeasures?

Watari — From our position as a rail operator, we're constantly tackling various issues so that accidents don't reoccur, based on past disasters. For instance, the introduction of an earthquake early warning system that indicates emergency stops to drivers in all trains, and the implementation of training for restoring services and safety education after accidents occur. But it's not as if these alone will be 100 percent adequate. I think that the only thing we can do is carry them out constantly and continuously.

We're also putting our efforts into covering human error, which could be said to occur constantly. For example, there's the thinking that "we were OK before and so we'll be OK now," and there's being lax in inspection work that essentially needs to be done, and so on. The scariest thing of all is when those kinds of things start accumulating. Things that ought to be done are written up in manuals, but mistakes happen somewhere because they're done by humans. It's important to make the assumption that humans will make mistakes. This is not particularly a disaster countermeasure, but we focus on it from the aspect of safety management, in terms that it inconveniences our passengers and poses problems for rail transport.

However, organizations regularly experience rotation. For instance, there's the problem of the mass retirement of the baby-boomer generation. With the retirement of employees who have encountered large disasters in the past, that experience and memory are cut off. So the question of how young employees can be connected to past efforts through in-house experiences has become a major issue.

Recognizing the dangers inherent in scientific techniques

Kaihara — President Watari has touched on mistakes and oversights, but these involved human power.

The philosopher Takeshi Umehara has called the disaster



Toshitami Kaihara

President,
Hyogo Earthquake Memorial 21st Century Research Institute *1

*1 The Hyogo Earthquake Memorial 21st Century Research Institute Carries out research and study on the numerous issues facing matured societies in the 21st century based on comprehensive verification spanning 10 years of the course of reconstruction since the Great Hanshin-Awaji Earthquake, and proposes policies to deal with such issues. The foundation was established in April 2006 as a comprehensive think-tank with the objective of contributing to the creation of 21st century civilization.



caused by the latest earthquake a “Disaster of Civilization.” This is a phrase rich in implication, isn't it. For whatever reason, modern civilization has given traction to “scientific techniques,” generating affluence and convenience. At the same time, the power of humans has grown to an astonishing extent.

The train, car and airplane, born from “scientific techniques,” can move at amazing speeds and over long distances, instantly widening the scope of human activity. Thanks to the development of information technology, we can understand what's going on the other side of the world in an instant.

It would be good if human power, enhanced by this kind of “scientific technique,” is always used in the correct way. Yet one wrong move can produce an extraordinary disaster. Nuclear-power plant accidents are such an example. In recent years, they have come to threaten the global environment, but it's not as if we can stop the development of “scientific techniques.” If that's the case, what should be done?

I think we need to recognize that “scientific techniques” are things that produce fundamental dangers, and that it shouldn't be used solely in the pursuit of affluence and convenience. Rather, the only thing for all of us to think about is how it should be used to create societies and towns where people can feel safe and secure.

Therefore, what President Watari just mentioned — about passing on learning from past experiences — is probably important and extremely valid, right?

What efforts is Nankai Electric Railway making to convey to the next generation the things learned from past experience?

Watari — For our records, we're compiling information-based articles and photos taken at the scene at the time that railways were mangled by the storm and flood damage, as well as responses by companies and opinions and evaluations by outside experts. We're trying to learn such things as what are the effects exerted on railways when disasters occur; whether the responses at the time were insufficient; and if people were dissatisfied, then why? Ideally, we wouldn't have a disaster or its accompanying problems, but we can't put an end to what has taken place, so it's important to apply this experience to what comes next.

Kaihara — The Hanshin-Awaji Earthquake was also a situation that had never been experienced before to such an extent, and so the prefectures, cities, towns and villages, and the residents as well, didn't know how to respond.

As a reflection of this, for 16 years we've been striving to

make common knowledge the importance of the compilation of information aimed at giving local officials at disaster countermeasures headquarters and others in charge the ability to make judgments that are appropriate and to make their decision-making imbued with a sense of speed; and the deployment of people, mainly ones with accumulated experience in standardized training on disaster prevention and reduction. If people are experienced, they can learn from then on. It's important to convey to the future generations the things we've learned from experience and our on-site experiences.

Responses by a railway company when disasters occur

What is at the core of the responses by Nankai Electric Railway when the disaster occurred?

Watari — It depends on the disaster situation, but first and foremost is seeing that passengers are not harmed. This is most important. Needless to say, it's a priority issue. Thus, safety is secured by first stopping the trains. Checks are done to see if there are any problems with the equipment or facilities. The aim is to resume service after the entire situation is judged in a calm manner. We try to resume service as soon as possible in the case of trains stalled between stations, and we will escort passengers to the nearest station. As for the resumption of service, the command office will grasp the situation, issue the appropriate information, and then after receiving this, the driver will make a judgment.

Also, depending on the situation we run shuttle services, switch to single-rail track, or implement other measures. As all of these are for the quick resumption of service, it is essential to secure the safety and security of the passengers, naturally, but also the residents living alongside the tracks and those using the trains every day. For these measures, we imagine various cases so that confusion doesn't occur. We routinely do simulations to prepare for such situations.

In addition, the damage from the tsunami in the latest disaster was enormous. After the tsunami warnings went out, however, people were evacuated by being led to elevated



President Watari views a display of photos taken of the Great Hanshin-Awaji Earthquake.

tracks, which minimized the damage. We're thinking about this as an issue we should tackle.

Kaihara — Another important problem concerns the people who have trouble getting home. In the area surrounding the big terminals of Namba in Osaka, etc. there are also lots of people who don't use Nankai rail services. If we don't decide beforehand what measures can be done for such people, then we're certain to have panic.

Watari — We're considering such responses as making facilities used for events or convention spaces available to those who can't get home. When we construct new buildings from now on, it'll become essential to have their design reflect their utilization as spaces for such people, I believe.

Kaihara — The idea of redundancy doesn't exist now in Japan's urban planning. Somehow, a town with surplus space is really affluent, I guess. Redundancy*2 means the utilization of overhead sections and making existing spaces available to the public. I think it will be indispensable for not just local governments, but for businesses as well, to actively tackle such efforts and make preparations. As the rail lines and areas alongside them in a sense share a common destiny, it's probably necessary for railway companies and residents along their lines to come together in critical times and work to create bodies like disaster countermeasure councils. Doing so would be one type of preparation and disaster reduction, I believe.

*2 Redundancy

Meaning "surplus" or "extra space," this word is used to mean alternative measures to secure safety, in terms of disaster countermeasures.

Protecting the environment also links to disaster prevention and reduction

At first glance, environmental conservation and disaster prevention may seem unrelated. However, Nankai Electric Railway links protecting the natural environment with disaster prevention.

Watari — We've marked the 126th year since Nankai Electric Railway was founded. Part of our history is blending in, as the environments alongside our rail lines are one type of scenery within regional communities. According to our way of thinking, protecting this scenery forever is also a disaster-prevention measure.

For instance, our trains travel in many stretches of mountainous areas or coastlines, not just through towns and fields. In order to maintain this scenery, we preserve mountains and prevent landslides from occurring so that train services are not interrupted. I've been listening to the President, and it has given me the sense that these efforts are for disaster prevention, and it seems natural they will probably lead to disaster reduction as well. Earthquakes and other occurrences aside, I think it would be difficult for disasters to occur as long as the natural environment is being carefully taken care of.

Our company owns Nankai no Mori, the woodland area (515 hectares) on Gomadanzan, said to be the roof of Kishu, and we've been planting cedar and cypress trees there for

over 30 years. This activity is also part of efforts for creating an attractive environment alongside our rail tracks. Recently, we've been doing more thinning than planting, and this is so sunlight can adequately penetrate the forest, promoting the growth of large numbers of plants and trees. As trees and plants absorb CO₂, they're behind the effective reduction of CO₂. Nankai Electric Railway Group involves all its companies to work on CO₂ reduction to prevent global warming. So we play a role in the maintenance and management of forests.

We will maintain our keen interest in environmental issues, mainly in the preservation of the natural environment and scenery, and we want to contribute to disaster countermeasures as well as preventing global warming.

"Mutual assistance awareness" that overcomes social barriers

Finally, please tell us your opinions on the role of regional railways and other forms of public transportation when disasters occur.

Kaihara — Railways are indispensable to society because they move large numbers of people. However, when disasters take place, they are expected to play a particularly important role, as a form of public transportation that will verify people's safety and transport them to safe locations. I hope that Nankai Electric Railway, which boasts a 126-year history, will

carry out its social responsibility as a public utility.

There seems to be an acute awareness that rail operations have a public mission, but are also private business, like electricity and gas utilities. When disasters or accidents occur, employees possessing specialized technology overcome the company barriers and work together to restore services, fully displaying their spirit of mutual assistance. The strength of this mutual assistance awareness gives us a keen sense of reassurance, and that gives rise to trustworthiness. I would like to continue this sense of public mission for long into the future.

Watari — Every time I look at the destruction caused by the Great East Japan Earthquake, I think about how disrespectful it was to the natural environment, and how we must face past disasters with humility. Working on railway operations day after day with a sense of humility while not forgetting this feeling of tension will enable us to have the appropriate responses should a disaster ever take place, I believe.

(Disaster Reduction and Human Renovation Institution, August 9, 2011)



Corporate Governance

Nankai is a company with a board of auditors, and the Company recognizes that strengthening the function of corporate governance is an important management issue and based on this the Company shall strive towards increased transparency in its management, fair and rational decision-making, not to mention the strict adherence to laws and regulations, and strengthening the supervisory functions that oversee these processes.

Execution of Duties

The Board of Directors of the Company consists of 13 directors (3 of whom are externally appointed directors) and 5 auditors (3 of whom are externally appointed auditors) and as a rule the Board meets once a month to decide on important business issues and to supervise the performance and duties of the executives. Due to the appointment of external directors, it is hoped that the efficiency and transparency of the management process at Board level will be improved.

Based on the fundamental management policies established by the Board of Directors, a Management Committee centered around executive directors of the Company meets once a week to discuss important management issues, provide regulatory control over management decisions as a whole and ensure that business operations are carried out in an appropriate manner.

Furthermore, with the aim of reinforcing the supervisory function of the Board of Directors and establishing a mobile system of business operations, the Company has implemented a system of corporate officers. Executive directors and corporate officers will work to optimize and increase efficiency in our business by sharing information related to important business issues and the performance of the Company, etc.

Auditing and Oversight Functions

The 5 auditors that make up the Board of Auditors shall meet, as a rule, once a month and carry out an audit of the business operations of the Company. The Board of Auditors meets regularly with the CEO and COO to exchange opinions and a system has been put in place so that the senior corporate auditors may arrange, whenever required, separate meetings with certain directors and employees to exchange opinions related to specific issues. Furthermore, the full-time corporate auditors attend directors' meetings, Management Committee meetings and other important meetings in order to listen to reports on the business status of the Company and the corporate group and important documents such as proposal forms that have been approved are referred to the corporate auditors for their review. The full-time corporate auditors, through their position and specialization in the company's business, report on the information they collect related to these matters as well as offering additional explanation on said matters to the external auditors. The external auditors provide guidance and opinions based on their expertise and experience outside of the Company. Thus by complementing each others' functions in accordance with their shared roles, the effectiveness of the audit is being enhanced.

In this way we are working to strengthen the functions of the corporate auditors and an audit office has been established as a full-time organization to assign clerical tasks related to the Board of Auditors and for audit inspections.

■ Corporate Governance System Diagram (as of June 24, 2011)

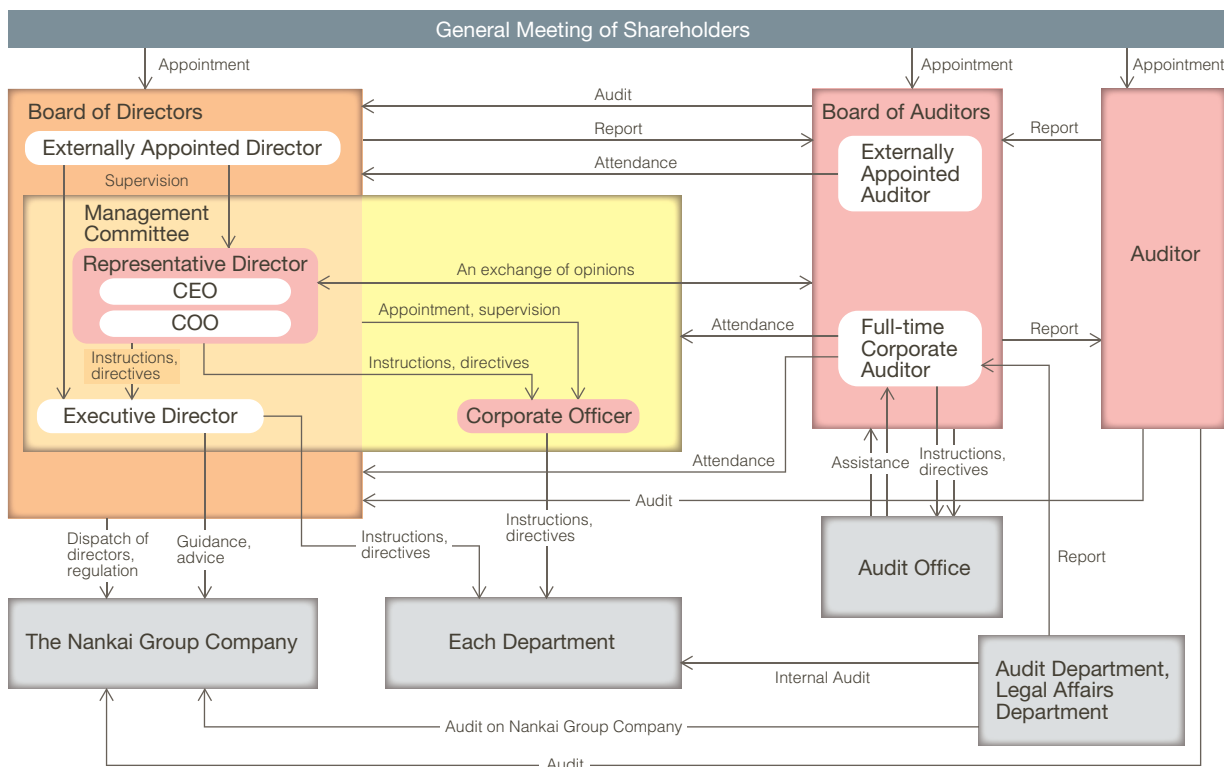

Internal Governance/Compliance

As part of our plan to reinforce our internal governance, the Company is thorough in its promotion of compliance management, as well as in its adherence to the law and the implementation of the full scope of our Code of Business Ethics.

Internal Governance

Internal governance is a means of internal management supervision to ensure that laws are not being broken and that incorrect practices, mistakes, etc. are prevented as well as promoting efficient and effective work practices across the organization as a whole. The Company uses the 6 different systems detailed below to ensure that operations run appropriately and efficiently.

- (1) A system to ensure that directors and employees assigned to positions carry out their duties in accordance with the law and the Company's articles of association**
- (2) A system to store and manage information related to the office and duties of the directors**
- (3) Regulations to manage the risk of loss and other issues**
- (4) A system to ensure that directors are carrying out their duties in an efficient manner**
- (5) A system to ensure appropriate business tasks across the corporate group**
- (6) A system to ensure that auditors are able to practically undertake an audit**

Establishing our Code of Business Ethics

In September 2001, as a means of entrenching corporate ethics within the organization, the Company compiled its Code of Business Ethics to uphold and promote compliance-based management.

Code of Business Ethics

1. We shall comply with laws and other social norms, and ensure soundness and fairness in our business activities
2. We shall endeavor to maintain healthy and good relations with customers, business partners, shareholders and other members of society at large
3. As a good corporate citizen, we shall actively engage in philanthropic activities
4. We shall reject all contact with organizations involved in activities in violation of the law or accepted standards of responsible social behavior

Department of Compliance Supervision

At Nankai, the Legal Affairs Department acts as the Department of Compliance Supervision. A Compliance Manager is assigned to each department (and office) within the company, and these managers hold regular meetings to share information and discuss compliance issues. Since fiscal 2008, each department has paid particular attention to contract documents, etc. to introduce a clause that prohibits any association with organized crime.

Since fiscal 2010 each department has put together a Compliance Education Plan, and these departments are following a concrete list of items as they strive to educate staff members on the issue of compliance.

Furthermore, the Nankai Group has appointed a Compliance Manager to each company in the group, and in addition to ensuring that information can be exchanged on a regular basis through smaller conferences for each industry or sector, or at general conferences that include all parties, the Nankai Group is also working to promote compliance education activities in the same manner as the Nankai Electric Railway.

Establishment of a Corporate Ethics Hotline (Internal Reporting System)

Since December 2002, the Corporate Ethics Hotline has provided employees with alternative to the regular operational reporting route when they have an issue, question, consultation or something they wish to report with regard to corporate ethics and/or compliance. The rules governing the Corporate Ethics Hotline were established to ensure that anyone using the facility for counseling or to report something would be protected.

Moreover, since April 2006 and the implementation of the Whistle-Blower Protection Act, the facility has also doubled as a whistle-blower hotline and its capabilities have been bolstered to encompass the entire Nankai Group of Companies.

Measures to Improve Safety

In accordance with Section 4, Article 19 of the Railway Business Act, Nankai hereby releases to the public its Safety Report, detailing the measures taken to ensure transportation safety during the previous fiscal year, as well as measures to ensure ongoing safety.

A Message from the Comprehensive Safety Administration Manager

The primary rule is safety first, above all things. Our greatest responsibility is to run our transportation business safely and this is reflected in our day-to-day work tasks.

Human error can lead to an accident, even if vehicles and safety equipment have been sufficiently prepared, due to the fact that human beings operate the equipment on the railway.

On the other hand, Nankai is aware of the importance of preparation in order to minimize casualties due to disasters caused by natural phenomena, and the Company is moving forward with its preparations for natural disasters, such as earthquake-proofing, etc. in addition to making preparations for procedures to follow in such an event. Consequently, the Company has bolstered its educational programs for all employees so that they retain a higher awareness of safety issues as well as training all staff to be able to respond in the event of a natural disaster. Also, through the implementation of regular internal safety audits, the Company is working to bolster its safety management systems.

Nankai will continue to have zero accidents on its railways as its target going forwards, and by creating a permanent safety culture, the Company is aiming for a railway that is trusted by its customers.



Shigeru Kuchino
Managing Director,
General Manager of
the Railway Business Division,
Comprehensive Safety
Administration Manager

Our Safety Policy

'Contributing to the Community' and 'Putting the Customer First' is our Corporate Philosophy. We regard transport safety as a top priority in order to justify public trust and provide excellent services for the customer. In addition to creating safety plans for all of our business activities and imbuing every employee of the Company from the President down with the importance of safety, we are ensuring safe transportation through comprehensive measures covering our railway facilities, rolling stock and employees.

On June 26th 2009 the Company revised its safety policy as detailed below. This concise document makes it easier for this ethos to permeate through to every employee.

Safety Policy

1. Safety is the Company's overriding priority; by working together we shall prevent accidents
2. As a company and in our work tasks we will strictly comply with all laws and regulations related to transport safety
3. The Company will enforce rigid checks and undertake the safest methods at work
4. In the event of an accident or a disaster, saving human lives takes priority over everything and the Company shall implement appropriate safety measures without delay
5. The Safety Management System shall be implemented in an appropriate manner and the Company will constantly look to improve the system

Revised June 26th 2009

Our Safety Management System

In accordance with the revisions to the Railway Business Law in March 2006, the Company established safety management regulations in October of the same year and these regulations have led to changes in the structure of the safety committees. The new organizational structure has a Safety Promotion Committee chaired by the company President as well as a Safety Promotion Implementation Committee chaired by the Comprehensive Safety Administration Manager. In order to permeate safety awareness and to build a culture of safety within the organization, the members that make up the Safety Promotion Committee come from a variety of departments and responsibilities, namely administrative planning, personnel, accounting & finance, which is a way of ensuring two-way communication between these departments and the Railway Business Division.

In terms of the organization of the safety management system itself, responsibilities are clearly defined as follows: the person holding the greatest responsibility for the Company is the President, followed by the General Manager of the Railway Business Division who acts as general manager for all safety issues related to transportation as the General Safety Officer. The Chief Manager of the Transportation Division is directly responsible for the operation and management of the rolling stock, as well as the guidance and management of the train drivers and conductors. This structure makes the role and responsibility of each manager very clear.



Safety Promotion Committee

Our Methods of Safety Management

In order to prioritize safety and ensure that essential information is shared, the Safety Promotion Committee – with the company President as committee chair – meets once every 6 months and the Safety Promotion Implementation Committee, chaired by the General Safety Officer, meets once a month.

These committees decide issues of safety policy, implement concrete measures, manage the progress of these measures through internal safety audits and review the implementation status of these measures. By doing so, a PDCA cycle has been established to increase safety, with appropriate review protocols as well as constant improvements to ongoing safety policy.

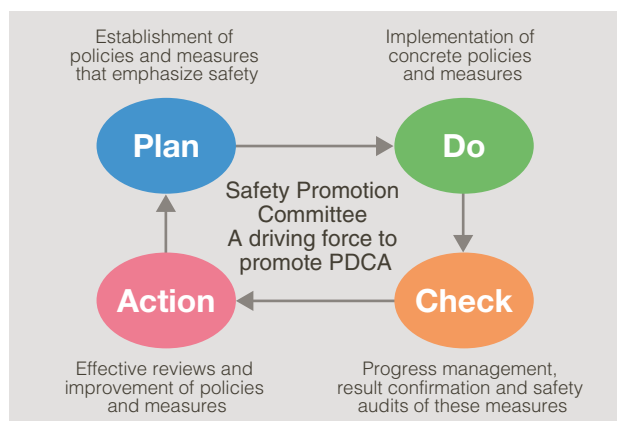

Status of accidents related to operation of the railway

There were a total of 21 accidents during fiscal 2010, 12 accidents involving level-crossings and 9 accidents that led to injury or death. The table below shows the transition of the number of accidents involving the railway over the past 5 years.

■ Number of accidents involving the railway (Unit: Incidents)

Classification	FY2006	FY2007	FY2008	FY2009	FY2010
Critical accident *1	0	0	0	0	0
An accident at a level-crossing *2	2	1	7	2	12
Fatality or injuries *3	2	5	12	15	9

*1 This refers to an accident involving a train collision (a train collides with another train or vehicle, or an accident that results from contact between two trains or vehicles), a derailment or a fire on a train.

*2 A train or a vehicle collides with or comes into contact with a person or a vehicle on the level-crossing, resulting in an accident

*3 Any incident where the operation of the train or vehicle results in injury or death (excluding accidents related to the incidents mentioned above)

● Critical accidents

There have been no critical accidents in the past 5 years.

● Accidents at level-crossings

In the past 5 years there have been 24 accidents at level-crossings. Ten of these incidents were due to people or vehicles trying to cross just before the train passed through.

■ Accidents at level-crossings (Unit: Incidents)

Classification	FY2006	FY2007	FY2008	FY2009	FY2010
Crossing just before a train passes	1	0	2	0	7
Going off the shoulder of level crossings	0	0	0	0	1
Others	1	1	5	2	4

● Accident resulting in injury or death

In the past 5 years there have been 43 accidents that resulted in injury or death. The main cause of these accidents were people entering the tracks, people on the station platform jumping in front of trains or people coming into contact with a passing train whilst standing on the platform.

■ Accident resulting in injury or death (Unit: Incidents)

Classification	FY2006	FY2007	FY2008	FY2009	FY2010
Entering the tracks	1	1	4	5	5
Jumping down from the platform	1	1	3	5	3
Contact with train on the platform	0	1	5	5	1
Others	0	2	0	0	0

Measures to Improve Safety

Transport Disruptions, Incidents

During fiscal 2010 there were 21 transport disruptions. Please refer to the data below for a breakdown of these different types of disruption as well as a year-on-year transition. Furthermore, there were no incidents reported during fiscal 2010.

*A 'transport disruption' refers to a situation that causes an impediment to transportation running on the railway, not including an accident involving the rolling stock.

*An 'incident' refers to a situation that could have resulted in an accident involving the rolling stock, but ultimately did not lead to an accident.

Number of Transportation Disruptions, Incidents (Unit: Incidents)

Classification	FY2006	FY2007	FY2008	FY2009	FY2010
Transport Disruptions	15	28	27	14	21
Incidents	1	0	0	0	0

Breakdown of Transportation Disruptions in fiscal 2010

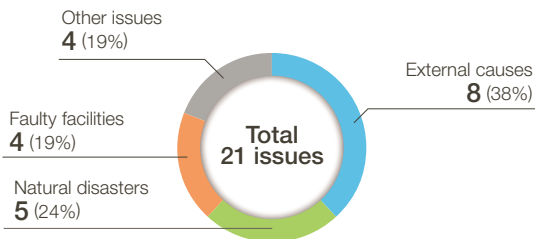

Measures to improve safety levels

In order to promote various measures including steps to improve safety levels of transportation services centering on operational safety facilities corresponding to ordinances issued by the Ministry of Land, Transport, Infrastructure and Tourism that partially revised prior ordinances stipulating technical standards for railways, as well as measures to prevent door-related accidents, the Company is planning and implementing the following items:

- Installation of new-type ATS
- Installation of new equipment to record traffic data
- Maintenance of the Deadman's device
- Raising station platforms
- An update of the Nankai Line Train Operation Management System

Monetary Investment in Safety

Our investment in safety facilities is in accordance with the planned requirements for each policy or measure. Up to now the Company has applied the same standard across all safety-related investments and for fiscal 2010 our investment in safety totaled some ¥5.0 billion. In fiscal 2011 we expect to invest a further ¥8.4 billion in safety.

Safety Investment

Amount invested (millions of yen)

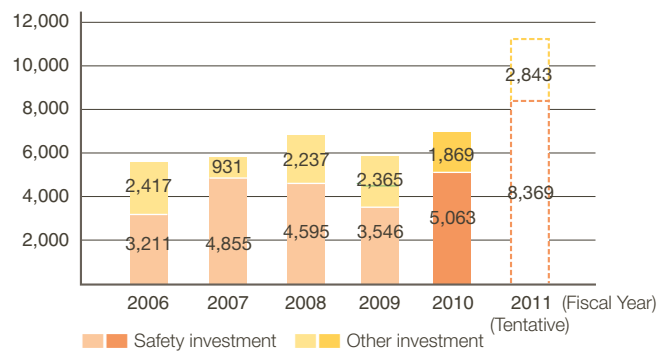

Introduction of Safety-Conscious Trains

The new Southern 12000 series Nankai Line Limited Express trains began service during fiscal 2011. The new trains feature energy-efficient VVVF controls as well as a number of safety features, such as grab handles on the seat shoulder, two-way communication devices for use in an emergency and yellow markings on the floor to make doorways more visible, to name but a few.



The Southern 12000 series Nankai Line Limited Express

Implementation of Safety Training

The Company believes that a robust education and training program is key to ensuring that safety techniques and practices are improved and passed on to the next generation of employees. With this in mind, each department plans and implements technical and skill-based training and guidance programs for all new, mid-level and experienced senior employees.

● Education for Station Employees and Staff Working on Trains

The Nankai Electric Railway has its own specialized training center, the Train Operation Training Center, where our staff, namely new employees assigned to station duty through to our conductors, drivers and deputy stationmasters all undergo staff training. Using CAI (Computer Assisted Instruction), a replica train carriage and a train operation simulator, the center runs a variety of educational programs, practical classes and training drills and this is where all our employees learn about safety, specifically working to raise and improve their awareness, consciousness and technical skills related to safety.

With regard to the training of staff assigned to work on the trains themselves, not only are these employees dispatched to training programs at the Train Operation Training Center, they also participate in regular training programs and specialized training that they will undertake at their workplace locations to further increase their awareness of safety issues. This is our way to respond to the trust placed in us by our passengers.

● Introducing a Safety and Peace of Mind Meister System

On January 1, 2011 the Transportation Division introduced a Safety and Peace of Mind *Meister* System.

This system has been established for the purpose of retaining and passing on the technical skills and abilities of the 'baby boomer' generation of Nankai employees, as well as to raise safety levels by increasing awareness and technical prowess, promoting manners and creating fans of the Nankai Railway, etc. Currently 8 'baby boomer' retired employees, each with experience at the foreman level of their chosen career path, have been rehired by the Company to serve as a Safety and Peace of Mind *Meister*.

A Safety and Peace of Mind *Meister* is issued with a special armband and works to improve safety levels by analyzing prior accidents and incidents where he had direct experience and to offer advice to younger managers as well as deliver lectures in order to foster and train workers in various types of jobs. Moreover, *Meisters* also strive to build up the Nankai fanbase as well as promoting manners through interacting with the public by visiting stations and riding the trains, in addition to visits and lectures at schools located near the Nankai Railway network.



Safety and Peace of Mind Meisters



Activities to promote manners during a school visit

● Technical Training

For workplaces with a technical aspect, the Company is moving forward with promoting the continuity of technological expertise from one generation to the next as well as implementing its policies of reforming the way we look at safety. This involves holding Safety Seminars, practical workshops and training drills as well as analyzing incidents from the past. The emphasis on raising awareness is focused on preventing our employees from getting stuck in a rut as regards safety. We have professional confidence in our proprietary systems and we work hard on training to improve our technical expertise and on fostering the next generation.

Furthermore, in order to advance our technical capabilities and further polish our techniques, we make use of training facilities to school our employees on different methods of checking and investigation, as well as running drills based on incidents that actually occurred in the past.



Level-crossing safety training facilities

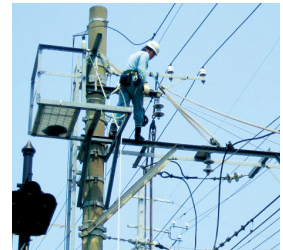

Work-site training on a feeder and a pole

Integrated Training on Restoration from Accidents

Nankai anticipates that a natural disaster could strike at any time and as such, each year the Company brings employees together for training and education and the Railway Business Division as a whole runs an integrated training program based on a hypothetical accident. The overall aim is to raise awareness of safety issues, so various scenarios are prepared, such as a large scale earthquake or a train striking a car, resulting in a derailment. Guidance is given on how to evacuate passengers and how to rescue the injured. Attention is paid to how the damage from a derailment or line breakage can be repaired and drills are run to illustrate which department need to be notified and how. During fiscal 2010 a simulation was staged at the Chiyoda Works and the scenario for the drills described a train that had derailed in the station area resulting in a lot of injuries.



Passenger evacuation training exercise

Together with our Stakeholders

Because our customers demand safety and trust, the Company is working hard to actively disclose information and to source the opinions of a wide variety of stakeholders. We hold these opinions dear and harness this feedback in our business activities.

Promotion of Barrier-Free Stations

During fiscal 2010 barrier-free construction was undertaken in 8 stations: Misaki Koen, Asakayama, Mikunigaoka, Hatsushiba, Takidani, Kawachinagano, Rinkanden-Entoshi and Hashimoto, with construction completed in 7 stations excluding Mikunigaoka.

As Hashimoto station is a shared facility with JR West, Nankai has moved forward with the Hashimoto Station Barrier-Free Project, a collaborative effort with JR West. The new facilities were completed and started services on March 1, 2011.

Additionally, on March 7, 2011 an overpass connecting station aisles and opposing platforms, went into operation at Misaki Koen, allowing passengers to use the elevators to move freely around the station yard. At Kawachinagano station on March 8, 2011, a multifunction toilet became available for use and on March 30, elevators were installed on the opposing platforms and put into service at the same location.

As a result, we have now installed 96 elevators in 39 stations including Namba, Shin-imamiya and Tengachaya, etc. and there are now 124 escalators installed in 28 stations (including 26 escalators equipped for wheelchair users) including Namba, Chiyoda and Kishiwada stations. We have boarding ramps for wheelchair users at 80 stations, Braille timetables and automatic ticket machines equipped with Braille in 92 stations and 48 writing tablets installed in 37 stations. We have installed textured paving and toilets with handrails in all our locations (99 stations) and 55 of our stations have dedicated toilets for wheelchair users. We are moving forward with installing fully-appointed multifunction toilets so that our stations are convenient for wheelchair customers, the elderly, pregnant ladies and people with disabilities.

Furthermore, inside the station concourse the Company has installed Braille maps, which are equipped with sensors that detect when a person is close by and a voice recording is triggered when these maps are touched by people with impaired sight. The voice recordings explain where certain facilities are located. This system is currently installed in 24 stations.



The improved ticket gates at Hashimoto station



The elevator at Hashimoto station

Actively Promoting Information Disclosure

In order to realize a sound management approach with a high degree of transparency, the Company is active in disclosing and sharing corporate information with shareholders, investors and society at large, such as our business performance and the status of our business projects, etc.

■ Status of Major Shareholders

(as of March 31, 2011)

Name	Number of Shares Held	Ratio (%)
Japan Trustee Services Bank, Ltd. (Trust Account)	26,861,000	5.1
Nippon Life Insurance Company	18,785,000	3.6
The Senshu Ikeda Bank, Ltd.	7,945,000	1.5
The Bank of Tokyo-Mitsubishi UFJ, Ltd.	7,368,000	1.4
The Sumitomo Trust & Banking Co., Ltd.	7,297,000	1.4
Sumitomo Mitsui Banking Corporation	7,147,000	1.4
Takashimaya Company, Limited	5,035,000	1.0
Kiyo Bank, Ltd.	5,005,000	1.0
OBAYASHI CORPORATION	4,541,000	0.9
The Master Trust Bank of Japan, Ltd. (Trust Account)	4,403,000	0.8

Topics

High Scores for the Degree of CDP Information Disclosure

Nankai has received high scores following an evaluation as to the degree of information disclosure conducted by the Carbon Disclosure Project (CDP), a survey of the top 500 companies in Japan by market capitalization. CDP is a non-profit movement created by a coalition of global financial institutions (534 companies have signed up to the project, with a combined asset base of US\$64 trillion) and CDP sends a questionnaire to major corporations all over the world that asks about their activities related to climate change, and the completed questionnaires are analyzed and evaluated (given a score out of 100) and the score is disclosed to investors. The survey has been carried out each year since 2003. 218 Japanese companies responded to the CDP 2010 questionnaire and Nankai came in 4th of all the Japanese companies with a disclosure score of 83 points.

Human Resource System that Promotes Self-Improvement

Since fiscal 2003, with the aim of realizing our corporate principles and attaining our management goals, each employee has been encouraged to undertake self-improvement and in order to ensure that the Company and the employee's division offer their full support the human resource system has introduced an 'objective management system' alongside an evaluation system.

In addition to creating two-way communication between the employee and his/her superiors, forming the basis of a relationship built on trust, each and every employee will mature and contribute to the business plan in accordance with the management cycle, with the overall goal of improving service levels across the Company as a whole.

Female Employment

In accordance with the spirit of the Equal Employment Opportunity Act for Men and Women, the Company decides to employ and assign positions to individuals on their personal merits, not their gender. In terms of our female employees, the Company has recruited 3 women to work in supervisory roles and they are currently serving as Managers as well as 1 woman working as Assistant Managers (as of June 2011).

Also in recent years, the Company has made progress in hiring women to work in railway on-site operations. Our railway business, used as it is by an unspecified large number of people, the female perspective and sensitivity is essential in order to improve our levels of service. We will continue to improve our work environment and look to expand the areas where our female employees can contribute.

■ Changes in the number of female employees



Employing People with Disabilities

The Nankai Electric Railway is conscious of its important social duty to employ people with disabilities and so to promote this employment program the Company established a special subsidiary, the Nankai Heartful Service Co., Ltd. in February 2005.

As of June 2011, 31 people with disabilities are employed as cleaners and to sort mail items, etc. and across the 7 companies that make up the corporate group, including the Nankai Electric Railway and other affiliates with special dispensations, people with disabilities make up 1.89% of the workforce.

Employing the Elderly

Since fiscal 2004, as a response to the increasing of the age from which the full social welfare pension started to pay out, the Company introduced a system whereby employees who were retiring could be re-hired by the Company, the basic approach being that whomever expressed a desire to continue work would be re-hired. As of June 2011, there are 313 people, including staff on loan, employed under this system in a variety of fields.

■ Changes in the number of people over 60 re-employed

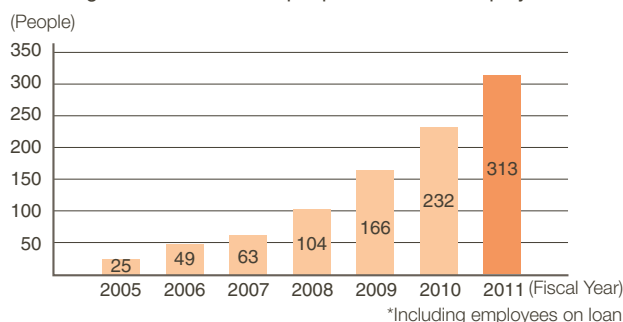

Promoting Work-Life Balance

● Promoting the use of paid leave days

In order to ensure consistency between maintaining one's health in the workplace and the employee's family life, the Nankai Electric Railway is implementing a number of measures, such as a system of planned annual leave, to promote employees to make use of their annual paid leave allowance.

In fiscal 2010 the take up of annual paid leave was 95% of the granted number of paid leave days, a much higher level than the normal rate of 47.1% quoted in the General Survey of Working Conditions published by the Health, Labor and Welfare Ministry.

Furthermore, the Company is working towards stricter controls on the amount of hours its employees are working and to reduce the amount of overtime work by limiting the number of consecutive rest days an employee works as well as the amount of after-hours work they put in, by spreading work tasks evenly across the workforce and a system of varying employee working hours, in order to make improved work/life balance for employees a reality.

● Supporting employees efforts to attain a better work-life balance

In order to support employees in their efforts to balance their working and family lives, the Nankai Electric Railway has enacted Childcare Leave Regulations, Family Care Leave Regulations, etc. and during fiscal 2010, 6 employees made use of the Childcare Leave system.

Moreover, in April 2010 the Company tabled its second set of action goals in the spirit of the Act for Measures to Support the Development of the Next Generation, whereby the Company is striving to create a workplace where employees raising young children are able to gain a better balance between work and their family lives.

Together with our Stakeholders

Education and Training Systems

Continuing on from the previous fiscal year, the most important and emphasized educational aim was to foster high-quality employees (with the goal of reinforcing the strength of the corporate group). To this end a number of different training programs were held with practical measures of Enlarging our Revenue Bases as well as Reinforcing Group Power, Building Crisis Awareness and Increasing Motivation as well as Approaches to CSR (Corporate Social Responsibility) Penetration.

■ Courses held in fiscal year 2010

	Subjects	Content	Number of Attendees
Compulsory Training	Newly-Appointed Chief Manager	Deciding on departmental strategy, etc.	9
	A Newly-Appointed Section Chief	Management, etc.	19
	Promoted personnel	Career Development, etc.	64
	New hires	Workplace conformity, a grasp of the Company outline	67
Training Courses for specific purposes	Employees of the Nankai Electric Railway Co., seconded employees, Corporate Group employees, etc.	Workforce management, financial management and improving business operations, logical thinking, etc.	285
Total			444

Creating a Workplace Where It's Easy to Work

● Human Rights Education

The most important issue for us as citizens is to respect human rights; it is enshrined in our constitution. In particular, for our Company, a public transport organization that manages a rail network, we feel human rights are such an important mission that we need to tackle this matter head-on, starting with social discrimination issues, as well as issues of race, gender and disability, etc. The Company has been hosting a human rights training program since 1971.

Moreover, since April 1985 when the Company established a Human Rights Issue Promotion Committee, the corporate group has constantly strived to educate and enlighten employees through the enriched content of its training courses in order for these employees to possess a correct appreciation of human rights issues and to deepen their understanding.

● Sexual Harassment: Prevention and Enlightenment Training

Based in the revision of the Equal Employment Opportunity Act for Men and Women in April 1999, the Company established a sexual harassment counseling desk to prevent sexual harassment incidents before they developed. Moreover, in order to enlighten employees of the Company and of the corporate group, a training seminar on sexual harassment prevention and education is held every year.

In addition to sexual harassment, since fiscal 2009 the Company has recognized that power harassment is a serious problem that can lead to low morale, mental health problems, etc. and as a consequence, in order to prevent all types of harassment before they develop the Company holds seminars on how to access the sexual/power harassment counseling desk as well as training sessions on sexual/power harassment prevention and education.

Mental Health Care

Nankai believes that mental health is an issue common to both enterprises and labor unions, and since April 2011 the clinical psychiatrist appointed by the health administration center has increased the number of counseling sessions per month from 2 to 3 and the Company has implemented a system, known as the Rework Trial Program (RTP) to support employees' smooth transition back to work after taking time off for mental health issues.

Support following the Great East Japan Earthquake

In order to be of some service to the people affected by the earthquake and to assist in the reconstruction of the quake-hit zone, the Nankai Group of Companies made a donation totaling 50 million yen to the Japanese Red Cross and other aid organizations.

Furthermore, the directors of the Nankai Group of Companies, together with management staff, managed to raise 2.76 million yen in donations, in addition to donation boxes that were set up in retail outlets at main stations on the Nankai rail network, as well as in retail facilities, amusement parks (Misaki Park) and so forth. Other fundraising activities included a 'donate' button on the beverage vending machines installed in Namba City, etc.

Moreover, Nankai and the city of Kawachinagano have entered into a cooperative collaboration agreement, one part of which was to run a bus service to shuttle volunteers to and from the affected area, which operated between May 13-15. The social welfare council of Kawachinagano city was the main party behind this initiative, and 30 volunteers, consisting of Kawachinagano citizens and local business people, traveled to the disaster volunteer center in Iwanuma City, Miyagi Prefecture, to lend a hand clearing mud from flooded homes, removing furniture and *tatami* mats, preparing meals, etc.

Environmental Policy and Management Systems

The Nankai Group wants to contribute to the prevention of global warming and the preservation of the global environment by reducing the environmental burden of its business activities.

Environmental Philosophy and Policies

The Nankai Group of Companies has established the Nankai Group Environmental Philosophy and by showing due consideration to the effect on the environment stemming from business activities, has approached the issue of creating a society that is kind to the environment. Furthermore, the Nankai Electric Railway has established a set of environmental policies, but with Head Office working to acquire ISO14001 certification, the Company believes it needs to make the policies easier to understand and more practical and as such the policies have been revised as shown below.

Environmental Philosophy (complete text)

We, the Nankai Group regard protection of the global environment as one of our missions. We always consider the environmental impact of our business activities, and work to foster a society that treasures the environment.

Environmental Policies (complete text)

Based on the environmental philosophy of the Nankai Electric Railway Group of Companies, the Nankai Electric Railway shall be sensitive to the effect on the environment of its various business activities, centered on its main business of the railway. The Company recognizes its social responsibility and has decided on the following environmental policy.

1. The Company will aim to promote the use of environmentally friendly modes of transport such as the railway and the bus, and at the same time to do its utmost to preserve the environment adjacent to its rail tracks.
2. The Company will strive to increase its environmental awareness, and will do its best to form a harmonious relationship with the local community as well as maintain open communication with customers through various methods of information transmission.
3. The Company will adhere to all laws, regulations and all other agreements with regard to the environment, as well as working hard to prevent any contamination.
4. In order to make its businesses run in an environmentally friendly manner, the Company is making constant improvements to its environmental management system.
5. Taking into account the effect on the environment of our business activities, the Company will implement a variety of measures with the aim of addressing the issues raised in the important points that the Company has settled as follows, and these shall be reviewed at regular intervals.
 - (1) Promote business activities that are considerate towards environmental preservation
 - (2) Work cooperatively with the local community: strengthen communication
 - (3) Reduce the burden on the environment through promoting the use of railways and buses

In accordance with these policies, Nankai is taking measures to further strengthen their promotion of environmental management.

Moreover, these policies will be applied by the Nankai Vehicles Service Engineering Company at their Head Office as well as the Chiyoda Works in order for the environmental management system to work effectively.

Shinji Watari
President, Chief Operating Officer
Nankai Electric Railway Co., Ltd.
September 1, 2011

Promotion System

In order to promote our environmental approaches and the smooth flow of information, the Company has established an Environmental Countermeasure Promotion Committee, with a secretariat located in the Promoting Environmental Policy Department. Furthermore, the scope currently covers the Nankai Electric Railway (Head Office, Railway Business Division, Real Estate Business Division, Distribution and Sales Head Office) but it will be developed to cover the entire corporate group in the future.

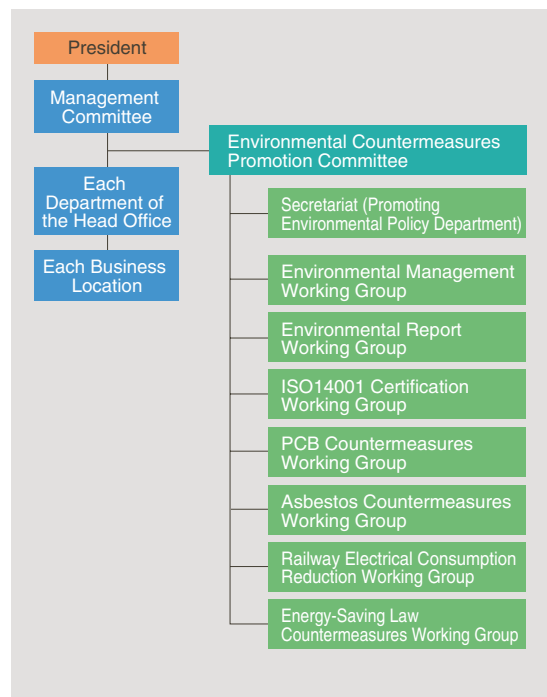

Working towards acquiring ISO14001 Certification

The Company has been aiming to implement an environmental management system based on ISO standards (ISO14001) and is striving to make constant improvements to its environmental burden. Both the Rolling Stock Department of the Nankai Electric Railway and the Nankai Vehicles Service Engineering Company (who together make up Chiyoda Works) acquired ISO14001 certification in March 2010. Then in November 2010, with the aim of extending the certification to cover the Head Office, a kick-off statement was declared by President Watari, and a project was launched to secure certification by March 2012.

Mid-Term Environmental Goals

Based on the results of the former 3-year business plan, the Kenshin 126 Plan, fiscal 2011 marked the start of the Rinshin 130 plan, a mid-term business plan, whereby the three companies that make up the main part of the Nankai Group embark on a 4 year program to reduce their CO₂ emissions by 4% (approx. 5,800t) as part of a new mid-term environmental goal.

■ Results of the Nankai Electric Railway Group 3 year plan (Kenshin 126 Plan) (fiscal 2008 to fiscal 2010)

Important Issue 1

Reduce the burden on the environment through promoting the use of railways and buses

The amount of fuel consumed by a train or bus in transporting a person is less than would be consumed by a car, so these modes of transport are kinder to the environment. Nankai promotes a reduced burden on the environment through planning for a modal shift from car use to railway and bus use.

Main Achievements in 3 years until fiscal 2010

1. Strengthening the Campaign to Promote the Use of Railways and Buses

- Press releases, the Nankai Area Top Total Site (NATTS) magazine for communities on the Nankai rail network, articles on the Nankai website, and creation of posters promoting environmental sensitivity are implemented.

2. Strengthening Services Related to Promoting the Use of Railways and Buses

- Implementing a Park and Ride system from the Misaki Park parking lot
- Nankai Bus issues an environmental bus pass; continues to offer the *odekake kippu* pass to support bus services
- Expand the number of shops accepting IC Cards (PiTaPa)

3. Promoting Barrier Free Access

- Installing elevators and other barrier free facilities in main stations (stations that handle more than 5,000 passengers a day); 18 stations fully fitted out
- Introduction of low-floor buses (20 buses) and one-step buses (79 buses) on Nankai bus routes
- Installation of 37 writing tablets, and AED units in 19 stations

Important Issue 2

Promotion of Business Activities that are Considerate towards Environmental Preservation

In all our business activities, from material procurement through to service and product provision, we will implement modifications and improvements, making consideration for the environment, such as environmental preservation, reduction of the burden on the environment, etc. our main theme and as a result, we will promote business activities that center on the environment.

Main Achievements in 3 years until fiscal 2010

1. Amount of CO₂ emissions (energy consumed) reduced by 3.2%

- Introduction of 20 energy-efficient trains to our rolling stock
- Replacement of 111 buses, all buses now fitted with drive recorders (Nankai Bus)
- Introduction of a solar powered electricity generation system at Izumisano station and Izumiotsu station
- Overhaul of the facilities at the Nankai Terminal Building (CO₂ emissions reduced: boilers 482t, transformers 22t, air conditioners 45t, cooling water pump inverters 299t, elevators 19t, cooling towers 11t)
- The hot water boiler at the Chiyoda Works converted to run on natural gas from heavy oil (a CO₂ reduction of 46.4t)
- Reduction in the amount of power consumed by the air conditioning units in the Sakai Higashi Building following upgrade (a CO₂ reduction of 390t)
- Changing the operation hours of silicon rectifiers at substations

2. Reduction in the Use of Resources

- Recycling of tickets (another company converts them to toilet paper, etc.), reducing the number of tickets in use (changing over to IC cards, etc.)
- Thorough separation of garbage at Head Office; reduction in the amount of paper used (compared with fiscal 2007 a reduction of 47t in the amount of non-industrial waste, reduction of paper: 595,258 sheets)
- Introduction of waterless toilet units as part of our water conservation measures (124 units installed in 30 stations; a reduction of approx. 68,676m³ in water consumption compared with water usage prior to installation)

3. Developing and Providing Goods and Services with the Environment as the Basic Concept

- The Minapita Ecopoint campaign raises money to support forestry fostering activities (between October 2008 and December 2010 approx. 12.8 million points had been collected, resulting in an equivalent donation of 1 yen for each point)

4. Strengthening Green purchasing

- After establishing a basic policy of green purchasing, our green online purchase rate of 88.3% was achieved and green offline purchase rate of 74.6% was achieved.

5. Reducing Vibrations and Noise

- Extending the section of long rail track (an additional 9.4km, a total of 115km)
- Ties with improved elasticity and rail scraping to reduce vibrations and noise (30.8km of rail scraping)

6. Thorough compliance with laws and regulations, etc. and promotion of preventative measures

- Appropriate management and disposal of type 6 asbestos
- Treatment for PCB within the legally prescribed period
- Employees to have health checks based on regulations to prevent disorders linked to asbestos (total of 504 employees)
- Appropriate measures to deal with the revision to the Energy Saving Act (submission of regular reports and a mid- to long-term plan, etc.)

Important Issue 3

Work cooperatively with the local community: strengthen communication

By developing relationships and working together with the various organizations that are located along our rail network regarding environmental preservation, we play a role in promoting environmental preservation activities in the local community as well as working to increase awareness of environmental issues.

Moreover, by improving the way we transmit information related to the environmental preservation activities of the Nankai Electric Railway Group, we promote a better structure for the relationship we enjoy with our stakeholders.

Main Achievements in 3 years until fiscal 2010

1. Promoting collaboration and working together with the local community, etc. on environmental protection activities

- Tree thinning activities by employee volunteers at Nankai no Mori, the woodland area owned by the Company (total of 5 sessions to date)
- Work with Osaka Prefecture on the 'Forest of Co-existence' in Sakai ward section 7-3 involving tree planting, weeding and biotope activities at the site of the Misaki town pit ruins (once a month)

2. Strengthening our Information Transmission Function

- Issuing CSR Reports (2008 to 2010), English version issued (2009, 2010), updating a picture book for children.

Important Issue 4

Strengthening our Environmental Management Promotion System

The functions of the Environmental Policy Promotion Committee, the main promotional body for the Company's environmental management program, have been strengthened. In addition to increasing levels both quantitatively and qualitatively, there are also plans to increase awareness and understanding of environmental management throughout the Nankai Group of Companies through a new environmental education program.

Main Achievements in 3 years until fiscal 2010

1. Strengthening the Operations of the Environmental Management System

- Twice a year, an event called Environmental Management Working is held and each department sets goals and holds a thorough review of their progress
- The Chiyoda Works acquired ISO14001 certification in March 2010, and the Head Office is currently working towards certification (scheduled for spring 2012)

2. Implementation of various environmental education programs

- Environmental management training (total of 5 sessions to date), environmental law seminar (total of 4 sessions to date)
- Encouragement to take the eco licensing examination; 41 employees have passed in the last 3 years
- Training for new employees (lectures and tree thinning were conducted); tree thinning was conducted only in the program for 2010

1. Promote business activities that are considerate towards environmental preservation

1. Establish a management system suited to achieving our goals of reducing the amount of CO₂ emissions (a 4-year goal)

- Companies compliant with the Energy Saving Act (Nankai Railway, Nankai Bus, Suminoe Kogyo) aiming for a 4% reduction
CO₂ emissions for fiscal 2010, all 3 companies combined: 145,000t-CO₂
⇒Aiming for a reduction of 5,800t-CO₂
Each company and each department shall collate emission data each month and confirm progress towards the goal.
- Main emitting companies in the Nankai Group to aim for a 4% reduction
CO₂ emissions for fiscal 2010: 225,000t-CO₂
⇒Aiming for a reduction of 9,000t-CO₂
*Main emitters: this target applies to 34 consolidated subsidiaries in the Nankai Group, excluding consolidated subsidiary companies with less than 100t of CO₂ emissions per year.
*This is more than 99% of the total emissions for the entire Nankai Group
Compliance
Reduction targets, administration of the progress plan, measures in case the target is missed (purchase of ecology rights, etc.)

2. Promoting the Implementation of J-VER (Offset Project)

*Aiming to be in credit during fiscal 2011

3. Convene the Environmental Measures Promotion Committee

4. Deepening and Enriching Environmentally-Related Working

- Implementation of various work practices, starting with ISO14001
- PCB Measures (all processes should be implemented by 2016)

5. Compliance with the Energy Saving Act

6. Compliance with the Wastes Disposal and Public Cleansing Act

2. Work cooperatively with the local community: strengthen communication

1. Participate in business projects related to the environment

3. Strengthen Information Transmission Functions Related to Environmental Management

1. Publish CSR Reports

*With regard to the content, cover only the main points and reduce the number of words and pages. Continue to produce the English version (other language versions to be considered going forward)

2. Continue to work with the CDP (Carbon Disclosure Project)

3. Enhance internal information transmission and enlightening activities

4. Strengthen the Promotional System for Environmental Management

1. Establish an Environmental Management System

- Attain a grasp of the results of the various promotional activities towards the 4 year goal; maintain a data-collection system
- Acquisition of ISO14001 certification
Promote the measures required to obtain certification within the Head Office departments
- Expand volunteer activities (Nankai no Mori, road repair, Forest of Co-existence, Biotope, etc.)

2. Implementation of Various Types of Environmental Education

- A fund to support employees that pass the Eco Licensing Examination (implemented since fiscal 2009)
- Hold seminars

FY2010 Performance and Strategic Policies for FY2011

The Company, department by department, sets goals for the mid-term as well as for individual fiscal years. Each year these goals are evaluated with the aim of reducing our environmental burden.

■ FY2010 Performance and Strategic Policies for FY2011

Important Themes	Environmental Goals	Concrete Measures and Targets to be met FY2010
Promoting the use of public transportation	Promoting the use of public transportation	Increase employee awareness by making use of various information tools and the internal company magazine
	Reinforcement of services to promote the use of trains and buses	Implement a Park and Ride policy at Misaki Koen Station
	Promotion of barrier-free initiatives	Complete barrier-free works at 7 major stations
Environmentally-sensitive business activities	Products and Services created around an environmental concept	Continuation of the minapita ecopoint program to support forestry
		Undertake sales promotion activities, environmental education activities at events
		Install Eco donation boxes in convenience stores
		Continue with the system whereby shareholder privilege cardholders donate to environmental causes
		Participate in environmental events for our trackside communities
	Measures to prevent global warming such as reducing CO ₂ emissions	Introduce 4 energy-saving cars
		Implement an eco drive program , with a 5% cut in fuel expenses
		Renew 15 highly-efficient transformers
		Install inverter-type elevators and escalators in 8 stations
		Continue with the operation of the solar energy electricity generation system at Izumisano Station, and start the operation of a system at Izumiotsu Station
		Further tree thinning and trimming activities at 'Nankai no Mori', the 39ha of woodland owned by the company
	Use of water resources; reducing resource waste	Reduce the expense of cartridges used by the waterless toilets
		Implementation of beautification campaigns such as litter collection at commercial facilities, etc.
	Preventing track noise and vibration	3.0km of additional long rail; a further 9km of rail scraping
	Promoting Green Purchasing	Aim to achieve an online Green Purchasing ratio of more than 80% and offline Green Purchase ratio of more than 60%
Strict legal compliance	Change carriage air conditioning refrigerants to those with an ozone layer depletion potential of zero	
	Regular air measurements to be taken in leased properties ascertained to contain asbestos	
Strengthening Environmental Communication	Promotion of preservation activities at Nankai Forest	Continuation of tree-thinning by volunteer employees at the forest land owned by the Company
	Enrichment of content for the Environmental Report	Publish CSR Report in Japanese in September, and in English in January
Environmental Awareness Education and Promotion	Reinforcing the Environmental Management System	Head Office departments to acquire ISO14001 certification
	Provision of environmental education	A training program for freshmen and two management training programs to be held during the year

Evaluation symbols: ◎ Goal attained and exceeded; ○ Goal attained (includes goals almost attained); × Goal not attained

	Results in FY2010	Assessment	Targets to be met by FY2011
	Press releases and the company homepage featured Eco Project 2010, minapita eco point donations, new type limited express trains, solar energy electricity generation systems, etc.	○	In addition to using various information tools, the internal company magazines will be used to raise employee awareness
	Implemented a program of discounts for people using the railway at the Misaki Koen Station parking lot in July 2010	○	Implement Park and Ride program at Suminoe and Ozaki Stations
	Work completed at 7 stations	○	Complete work at 5 stations
	In one year approx. 5.9 million points were totalled up, which means that approx. 5.9 million yen was donated to 9 organizations	○	Continue the minapita ecopoint program, promotion of plant and tree cultivation as part of the Koya Hana Tetsu Project
	Recycled paper was used for the Christmas event, eco-bags were distributed when Namba Parks underwent renewal	○	Implement the Namba Eco Project 2011, install battery chargers for electric vehicles at the Namba Parks parking lot
	After the earthquake, donation boxes were swapped out for earthquake recovery relief donation boxes so the total was limited to 200,000 yen	×	Continue having the eco donation boxes at an3 and nasco+ stores and aim to raise more than 240,000 yen
	779 people gave donations to Environmental Protection Agencies that were equivalent to 2,337 saplings	○	Continue with a system to enable shareholders to donate to Environmental Protection Agencies
	Participated in eco events in Sakai City, Namba and the Train Festival	○	Set up an Eco Booth at the Sakai Festival and the Train Festival
	Introduced 8 energy-saving cars	○	Introduce 8 energy-saving cars and remodel 4 cars to energy-saving type
	Implemented the eco drive program that resulted in a 4.7% reduction in fuel expenses	○	Implement the Eco Drive program and appropriate car maintenance to deliver a 1% reduction in fuel consumption
	13 highly-efficient transformers installed	○	Install 15 highly-efficient transformers
	Inverter-type elevators installed in 7 stations	×	Install inverter-type elevators in 4 stations
	Test operation of the system commenced in January at Izumiotsu Station; the system at Izumisano Station generated 10,835kWh	○	Generate 71,563kWh through the solar energy electricity generation system at Izumiotsu Station
	39ha of forest thinned and trimmed	○	Trim, thin and fell 32.3ha of forest
	Cartridge unit cost reduced by 500 yen	○	Some station service equipment to be switched off, lighting in stations and in cars to be dimmed
	The zero garbage movement was implemented in June and March	○	Implement beautification activities such as litter collection at commercial facilities, etc.
	Long rail extended by 3.5km, total length of 115.2km; 11.6km of rail scraping	○	Long-rail to be extended by 4.8km, rail scraping, corrections and extensions by 10.0km
	Online Green Purchasing ratio of 88.3% and 74.6% offline achieved	◎	Aim to achieve an online Green Purchasing ratio of 85% and offline Green Purchase ratio of 70%
	Changed carriage air conditioning refrigerants to those with an ozone layer depletion potential of zero	○	Promote change to substitute car air conditioning refrigerants
	Implemented in 2 properties in September 2010	○	Regular air measurements to be taken in buildings ascertained to contain asbestos
	In May 2010 company employees volunteered to thin and trim trees twice	○	Continue with tree-thinning activities
	CSR Report published in September 2010, with the English Edition published in February 2011	○	Continue to publish Japanese and English versions of the CSR Report
	Kick-off Declaration aimed at expanding certification to Head Office in November 2010	○	Head Office departments to acquire ISO14001 certification
	A total of 159 employees underwent training over three sessions held during the year	○	Implement 3 environmental study seminars per year, prompt employees to take Environmental and Social Certificate examinations

Reducing CO₂ Emissions to Prevent Global Warming

The Nankai Electric Railway is looking to improve transport efficiency by introducing new energy-saving trains, etc. to prevent further global warming.

Aims for fiscal 2008	Actual performance in fiscal 2010	Aims by fiscal 2020
Over three years (fiscal 2008 to 2010) the three companies together are looking to reduce emissions by 3% (some 6,240t).	A reduction of about 6,600t (3.2%) in three years.	A reduction of 15% compared with per unit of transportation volume 1990 (a reduction of 11.3% as of 2010)

Reducing CO₂ Emissions (Final Report)

The CO₂ emissions of the Nankai Electric Railway, Nankai Bus and the former Nankai Urban Development Company in 2007 totaled 208,000t and a target was set for fiscal 2010 of a reduction in CO₂ emissions of 3% (to 201,760t, a reduction of 6,240t). The emissions total for fiscal 2010, the final year of the project, totaled 201,400t (a reduction of approx. 6,600t). Due to cost reductions, the three years of the program were not sufficient for the Company to introduce all of the energy efficient trains as planned, but by converting the facilities in locations such as Namba City, etc. to more energy efficient models (such as boilers and coolant pumps, etc.), and by installing drive recorders on all Nankai buses to promote eco driving, we were able to reach our goal.

Moreover, comparing the CO₂ emissions in unit requirement for each of our passenger transportation facilities (using the amount of CO₂ emitted when transporting 1 person 1km), the unit requirement for the railway is only one-ninth that of private cars. The Company will expand upon its environmental advantage through PR, and will work towards further reductions in CO₂ emissions by planning on a modal shift to persuade car owners to use the railway.

■ Transitions of CO₂ emissions for the Nankai Electric Railway Company

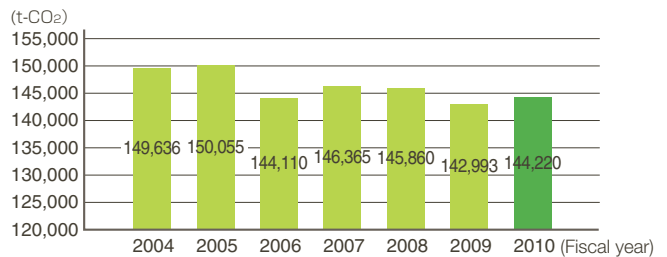

■ CO₂ Emission Unit Requirement by Passenger Transportation Facilities (fiscal 2009)

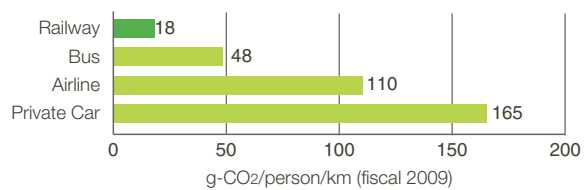

Materials: from the Ministry of Land, Infrastructure, Transport and Tourism homepage (CO₂ emissions amounts by Transportation Section)

■ Transitions of CO₂ emissions for three companies in the Group

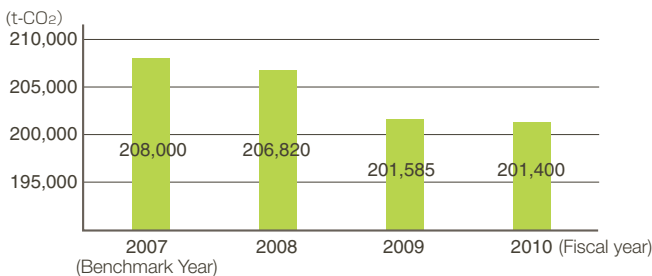

The criteria for a 3% reduction were as follows:
Conditions:

The figures do not include the CO₂ emissions of tenants such as leased buildings and convenience stores, etc.

In order to make comparisons possible, the emission coefficient for electrical power consumed by railways and buses was set at 0.555kg/kWh, and at 0.338/kWh for the former Nankai Urban Development Company (the reports that appear in the Energy Saving Act use 0.294kg/kWh). Accordingly, the environmental burden data on P25 differ from the above.

Energy Reduction in our Business Activities

● Reduce the Amount of Electricity consumed by the Railway

The most effective way of reducing CO₂ emissions is to plan a way to reduce the amount of electrical power used by the railway. We understand that this is an important issue. The amount of electricity used by the railway was 252.53 million kWh in fiscal 2010, of which train operation made up 83.2%. The amount of CO₂ emissions attributable to electrical power used by the railway was 140,156t-CO₂*, or some 97.2% of the total emissions for the Company at the 3-year target (144,220t-CO₂).

Moreover, electricity consumed by the railway peaked during fiscal 2005 and has been steadily reducing ever since.

*This calculation was also made using the emission coefficient of 0.555kg/kWh

■ Transitions of electricity consumption for train operations

(Fiscal year)

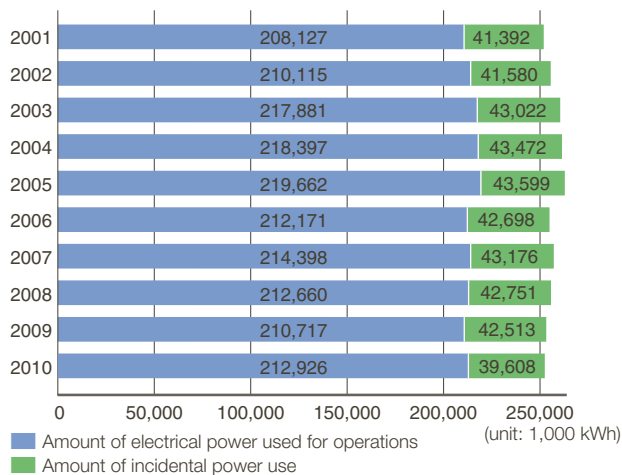

● Installation of a Power Factor Improvement Phase Shunt Capacitor

In order to aim for more effective usage of electrical power, since 2004 power factor improvement phase shunt capacitors have been introduced at the high voltage distribution facilities at substations.

Moreover, with regard to our aim for efficient use of the electric power that we use for train operations, by adopting the up and down track lump-sum feeding system by connecting both sets of tracks electrically, we allow trains on both tracks to utilize the regenerated electric power mutually.

■ Structure of the up and down track lump-sum feeding system

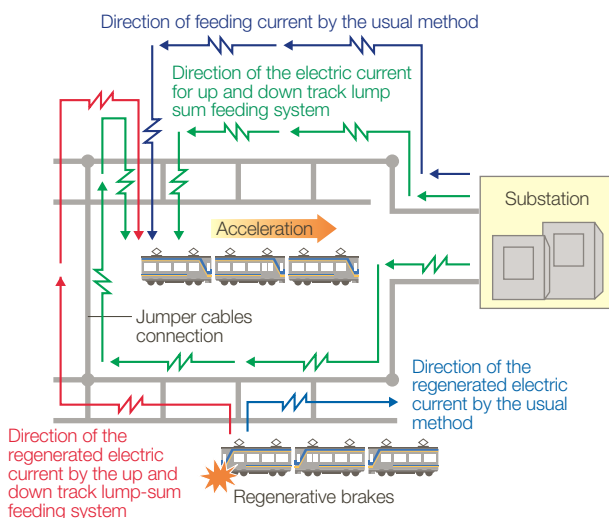

● Regenerative Brakes and VVVF Inverter Controls

The generating brake is a kind of electrical brake that uses a resistor to change electricity to heat. However, because this method changes electrical energy into heat, the energy is lost and cannot be used in an effective manner. A regenerative

brake can return electrical power to the power cables for other trains to use effectively.

Moreover, train speed is controlled by VVVF inverter controls, a speed control method using an inverter device which changes the voltage and frequency of signals to control revolutions and motor torque, according to the speed and acceleration required.

Conventionally, speed has been controlled using a resistor to act as a load on the motor, which is one way of adjusting voltage. In this way some electrical energy becomes heat and is released, generating some electrical power loss, but with VVVF inverter controls, there is no wasteful electrical power consumption, so it is an effective method of electrical power conservation.

As of March 31, 2011, of the 690 cars that run on the Nankai railway, 262 (38.0%) are fitted with regenerative brakes and 212 (30.7%) are equipped with VVVF controls.

■ How the electrical power regenerative brake mechanism works

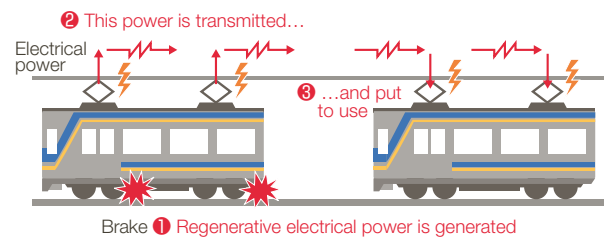

Topics

Operating a Solar Power Generation System at Izumiotsu Station

On January 25, 2011 the solar power generation system at Izumiotsu Station began operating.

This system has a maximum output of 73.3kW and is capable of supplying approx. 71,000kWh, part of the total annual power consumption at Izumiotsu Station. This is expected to be equivalent to a reduction in CO₂ emissions of approx. 25.5t. The electricity generated by this system is used to power elevators and escalators, air conditioners, lighting, etc., as well as all of the facilities in the station together with the power generated by the existing system. Moreover, with the installation of a display just outside the Station grounds that shows how much power is being generated, at that instant, as well as how much electricity has been produced that day and what this means in terms of reduced CO₂ emissions.



The solar power generation system at Izumiotsu Station

Protecting Biodiversity

The beautiful woodland and biotope located along our railway track sustain the existence of a variety of flora and fauna. Moving forward, we will strive to introduce the importance of living organisms and protect biodiversity.

Aims for fiscal 2010

Reducing CO₂ through the promotion of tree-thinning (20ha, 100t)
Activities to preserve Nankai no Mori

Actual performance during fiscal 2010

Reducing CO₂ through tree-thinning (26ha, 130t)
On May 8, 47 people participated in activities to preserve Nankai no Mori

A Bioenvironmental Survey of Namba Parks

Completed in 2007, Namba Parks was constructed on the 12.7ha site of the former Osaka Ballpark and this compound greenery urban site was completed by the 'Namba District Redevelopment Plan'. Before the redevelopment there was no trace of greenery in the area, but Namba Parks is built around preserving a tree-based ecosystem, an ecological landscape that spreads over approx. 11,500m² of roof area (approx. 5,300m² of greenery, approx. 6,200m² of passageways and open spaces). There are approx. 70,000 trees and plants at Namba Parks, consisting of 300 different species (of which approx. 50 are tall trees and 250 are smaller trees and shrubs).

In order to make the biofacies apparent at Namba Parks, Nankai began last fiscal year to take a bioenvironmental survey to list all of the species of flora and fauna.

● Avian Life

Using the fixed point survey method (whereby 2 fixed points are decided in objective site for the survey, and all life forms that enter the survey area during a 10 minute period are recorded), 7 types of avian life were confirmed, with the majority species well suited to the urban environment. The individual species were totaled up and compared against the list of protected species and those species on the red list as selected important species. At Namba Parks, three avian species, namely the peregrine falcon, eastern crowned warbler and the old world flycatcher, were confirmed. The peregrine falcon appeared in February and May, the eastern crowned warbler appeared in the crown of the bamboo leaved oak in May and two old world flycatchers were spotted on the outer branches of the tree nursery in October.

The surveys taken over the past two years have identified 3 orders, 15 families and 18 species of birds.

■ Location Map of Important Species

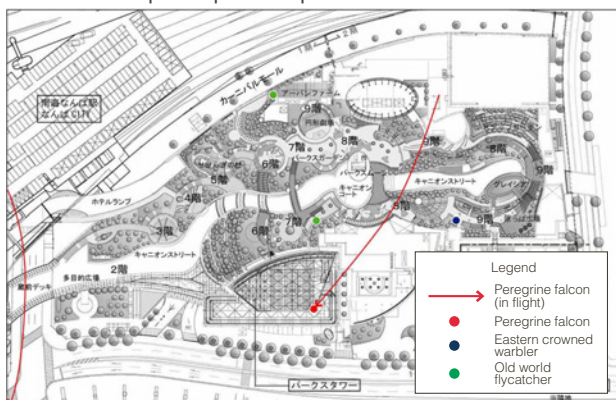

● Insects and Arachnids

On the other hand, with regard to insects and arachnids, a number of habitats and species were observed using the find and collect method. The result of the survey carried out at Namba Parks over a period of 2 years have identified 12 orders, 64 families and 129 species of insects and 9 families and 18 species of arachnid, and using the same approach as the avian species to identify important species, the presence of *calommata stigmatum* was confirmed. The surveys will continue and add to the data used for maintaining Namba Parks, as well as helping establish an area like a butterfly garden where dietary vegetation is planted. Namba Parks is moving forward in creating an environment that can act as a stable habitat for insect life.

■ Map of Characteristic Insect Habitats

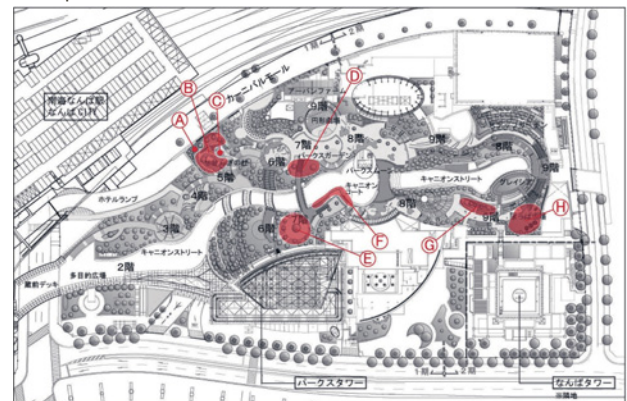

- A Stream
- B Wooded copse near stream
- C Japanese clethra flowers
- D Flowerbeds
- E Around benches
- F Abelia planted along stairs
- G Flowerbed with hydrarch vegetation
- H Field



Survey scene



Old world flycatcher



Peregrine falcon

Effective Use of Resources and Consideration for the Local Environment

It is expected that in the future the effective use of water resources and the issue of greenhouse gases will become very serious issues and as such, we have installed water-free urinal as part of our water conservation policy.

Aims for fiscal 2010

Promotion of green purchasing (Online purchase target of 80% and above, offline purchase target of 60% and above)
 Reduction in train car vibration and noise
 Extension of long rails: 3.0km
 Extension of rail scraping: 9.0km

Actual results for fiscal 2010

Promotion of green purchasing (Online purchase result: 88.3%, offline purchase result: 74.6%)
 Reduction in train car vibration and noise
 Extension of long rails: 3.5km
 Extension of rail scraping: 11.6km

Reducing water consumption by installing waterfree toilet units

With the aim of providing comfortable toilet facilities and still contributing to the conservation of our water resources, the Company has been installing non-flushing toilets — waterfree urinals for men — since March 2007 when a test unit was installed in Hakotsukuri Station. As the results of this test has confirmed significant savings in terms of water use, from fiscal 2008, the Company moved forward with installing large quantities of these waterfree units. These units allow for water use conservation and control over the Company's use of the freshwater and sewer mains, which is effective in reducing CO₂ emissions.

Currently, 124 units have been installed in 30 stations. The water conservation effect of the waterfree units currently installed adds up to a total of approx. 68,676m³ of water a year (compared with fiscal 2007 when these units were yet to be installed in the railway section), a large reduction in the total water consumption of the Company as a whole, from 472,470m³ to 388,879m³. At the same time the reduction in CO₂ emissions are thought to be approx. 48.5t annually.

■ Transition of water use for each fiscal year

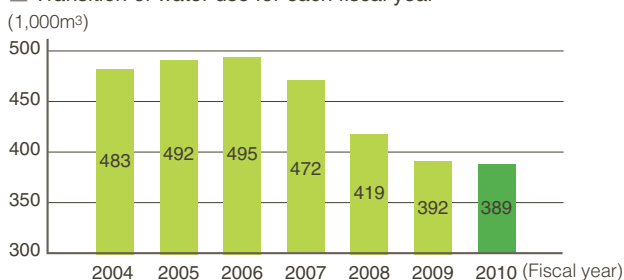

Promoting Green Purchasing

Since fiscal 2009, when the Company began its policy of green purchasing, the goal was to specify the purchase of products (such as office supplies, etc.) that could be bought online (purchasing via the internet through PCs, etc.) to a rate of green purchasing of over 80%. In fiscal 2010 we were able to exceed this target with a green purchasing rate of 88.3%.

Of the Company's 68 departments, 11 did not manage to attain a green purchasing rate of 80% and Nankai is looking at ways to improve their performance going forward. On the other hand, green purchasing of offline purchases (office supplies as ordered by the Material Purchasing department) for fiscal 2010 came in at 74.6% (against a target of 60%).

Promotion of Long Rail and Rail Scraping

Rails are connected with joints and when trains pass over these joints, the result is noise and vibration. Long rails have fewer joints, thus reducing the noise and vibration as well as reducing the maintenance work on the railway. As of fiscal 2010, Nankai has laid a total of 115km of long rail converted to single track on the Nankai Main Line and the Koya Line, over 70% of the track where it has been possible to install these long rails.

Moreover, the rail scraping car (a maintenance vehicle) runs on the rails and scrapes away scratches and uneven sections from the rail surface, again a measure to reduce the noise and vibrations on the rails. In fiscal 2010 the Company scraped 11.6km of rail.

Environmental Accounting

Environmental accounting is a way to measure the cost of the Company's business activities in terms of environmental preservation and quantify as much as possible the effect of the Company's environmental preservation activities.

The environmental accounting practices used during fiscal 2010 are as follows.

■ Environmental Preservation Costs

(Unit: ¥1,000)

Classification	Main content	Amount of money invested		Amount of expenses	
		FY2009	FY2010	FY2009	FY2010
Business area internal costs		1,000,946	1,603,944	264,343	257,212
① Environmental contamination prevention costs	Prevention of atmospheric pollution, water pollution control, noise pollution, vibration pollution	88,595	51,390	108,472	100,183
② Global environmental preservation costs	Prevention of global warming, energy conservation, prevention of the destruction of the ozone layer	894,915	1,454,474	8,306	4,786
③ Resource recycling costs	Conservation of resources, reduction in waste products, recycling, processing of waste products	17,437	98,079	147,565	152,244
Upstream and downstream costs	Recycling of used tickets, green purchasing	—	—	171	336
Cost of management activities	Environmental education, costs related to ISO14001	—	—	14,429	70,025
Research and development costs	Research and development related to environmental protection	—	—	400	0
Cost of social activities	Tree planting, beautification campaigns, attendance at and support of environmental seminars, environmental advertising	17,977	6,949	24,200	15,671
Cost equivalent to the damage suffered by the environment		—	—	—	—
Total		1,018,923	1,610,893	303,543	343,245

■ Effects of Environmental Preservation

Classifying the Effects of Environmental Preservation	Types of Indicator		① Previous term (standard time period)	② Current term	(①-②) Difference between the standard terms	
The effect of environmental preservation on the resources invested in our business activities	Gross energy investment amount (GJ)	Breakdown	Electricity (GJ)	945,567	1,253,578	- 308,010
			Gas (GJ)	916,711	1,075,936	- 159,226
			Fuel (GJ)	18,202	169,178	- 150,976
		Amount of water used (m ³)	10,655	8,463	2,191	
	Amount of OA-paper used (sheets)		391,800	388,879	2,921	
			5,891,769	4,841,409	1,050,360	
The effect of environmental preservation on the environmental burden and waste products generated by our business activities	Gas emissions from the greenhouse effect (t-CO ₂)	Breakdown	Electricity (t-CO ₂)	76,619	97,845	- 21,226
			Others (t-CO ₂)	74,865	87,868	- 13,003
		Industrial and non-industrial waste (t)	1,754	9,977	- 8,223	
				15,465	9,786	5,679

■ Economic effects of environmental preservation countermeasures

(Unit: ¥1,000)

Effective content		Amount
Profits	Business income from recycling waste and recycling used products (old rails, wheels, scrap iron)	84,222
Reduction in expenditure	Energy conservation = reduction of energy costs	9,807
	Recycle waste products to reduce waste processing fees	5,085
Totals for economic effects		99,114





■ Indicators of Environmental Efficiency

CO ₂ emissions for a car per 1km run (kg-CO ₂)	0.79
CO ₂ emissions against operating revenue (t-CO ₂ /million yen)	0.98

- The scope of these sum totals only covers Nankai Electric Railway
- Data was collected between April 1, 2010 and March 31, 2011
- References the 'Environmental Accounting Guidelines Ed. 2005' as published by the Ministry of the Environment and conforms with the 'Environmental Accounting Guidelines for Private Railway Businesses Ed. 2008' as published by THE ASSOCIATION OF JAPANESE PRIVATE RAILWAYS
- Only processes where a concrete cost could be assigned to environmental preservation have been included
- No depreciation has been included in the expenses associated with environmental preservation costs
- One of the economic effects of environmental preservation policies is a reduction in energy costs. Only the energy cost reduction items for energy in which the environmental preservation effects were recognized have been included in the expense data
- With regard to the amount of greenhouse gas emissions, our emission coefficient for electricity for this fiscal year is 0.294kg-CO₂/kWh.

Environmental Burden Data

In accordance with the revised Energy Conservation Law, this fiscal year the Company is releasing to the public the environmental burden data that was submitted to various government ministries. Due to the merger with Nankai Urban Development Co., the current fiscal year has seen a large scale increase in the amount of energy consumed at Head Office and other facilities.

INPUTS		Railway Business	Head Office and other Facilities ^{*1}	
Energy 	Electrical power	252,861,769kWh (+2,044,538kWh)	46,009,410kWh (+42,184,779kWh)	
	Urban gas	593,885m ³ (+224,093m ³)	3,490,252m ³ (+3,451,252m ³)	
	Propane gas	25,921kg (-1,597kg)	372kg (-5kg)	
	Gasoline	28kℓ (+1kℓ)		
	Light oil	64kℓ (-2kℓ)	860ℓ (-480ℓ)	
	Kerosene	22kℓ (+0kℓ)	13,918ℓ (+2,455ℓ)	
	Heavy oil	0kℓ (-103kℓ)	80,400ℓ (+44,200ℓ)	
	Total	2,552,824GJ	615,269GJ	
Water 	Water	302,612m ³ (-8,658m ³)	86,267m ³ (+5,737m ³)	
	Paper 	Paper	1,884 thousand sheets (of paper) (-787 thousand sheets)	2,957 thousand sheets (of paper) (-263 thousand sheets)
OUTPUTS				
CO₂ emissions 	CO ₂ emissions	76,068t-CO ₂ (-14,469t-CO ₂) ^{*2}	21,777t-CO ₂ (+20,165t-CO ₂)	
	Waste 	Metallic waste	1,257t (-200t)	1t (-1t)
Waste plastic		74t (-18t)	2t (-11t)	
Sludge		168t (+57t)	0t (-42t)	
Waste Alkali		1t (+1t)		
Glass and ceramic waste		4t (-1t)		
Waste paper		16t (-8t)	4t (0t)	
Waste wood		194t (+71t)		
Rubber waste		0t (+0t)		
Earth displaced by construction ^{*3}		0t (-1,608t)		
Waste oil		1,352t (+1,319t)		
Debris		1,899t (-4,703t)		
Slag		7t (-2t)		
Waste asbestos		4t (+3t)		
Concrete		2,243t (-903t)		
Other industrial waste		1,020t (-267t)	0t (-1t)	
		Total amount of industrial waste generated	8,239t (-6,259t)	7t (-55t)
		Total amount of non-industrial waste	1,077t (+634t)	463t (0t)
		Total	9,316t (-5,625t)	470t (-56t)

Figures in parenthesis () shows comparison with the previous fiscal year

*1: Due to the merger with Nankai Urban Development Co., Ltd. that took place on October 1, 2010, the amount of energy consumed includes the related increase from October 1 onwards. However, as the amount of water usage cannot be divided proportionally, for the sake of convenience this has not been included.

*2: These numbers represent the data submitted by the Company to the Kinki Transportation Bureau in accordance with the Energy Conservation Law. The CO₂ emissions totals were based on the amount of electric power consumed and calculated using the emission coefficient as set by Kansai Electric Power Co. of 0.294kg-CO₂/kWh and this is why these figures differ from the CO₂ emission data on P20.

*3: Earth displaced by construction work is not industrial waste, but for the sake of convenience it is counted here as industrial waste.



- If you have any questions or comments about this report, please contact:

**Promoting Environmental Policy Department
Nankai Electric Railway Co., Ltd.
(Secretariat of the Environmental Measures
Promotion Committee)**

5-1-60 Namba, Chuo-ku, Osaka
542-8503, JAPAN

Tel : 06-6631-6300
Fax : 06-6632-6257

URL: <http://www.nankai.co.jp/>



As a symbol of the proactive environmental activities of the Nankai Group going forward, the Group has established an eco-slogan and an eco-logo. Emblematic of our coexistence with our local communities and the natural environment, the green leaf design personifies our drivers and our trains – an illustration of our commitment to running our trains in tandem with our passengers.